

型式	製品番号
YLT110	037900000000
YLT110E	037900000009
YLT110L	037900000008
YLT110EL	037900000084

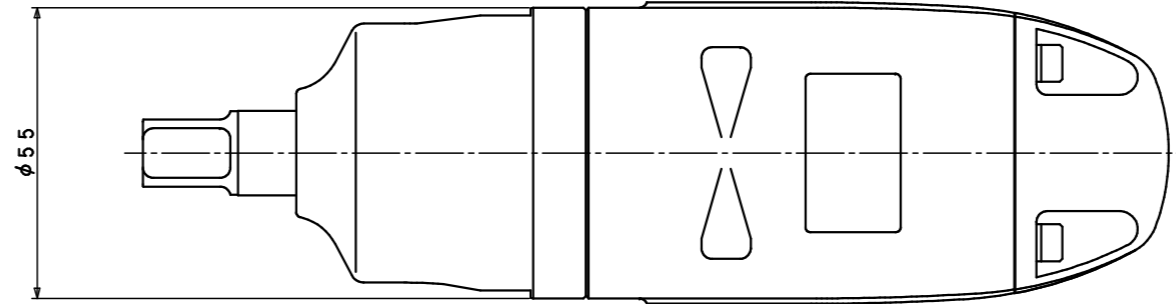

YLT110  
YLT110L

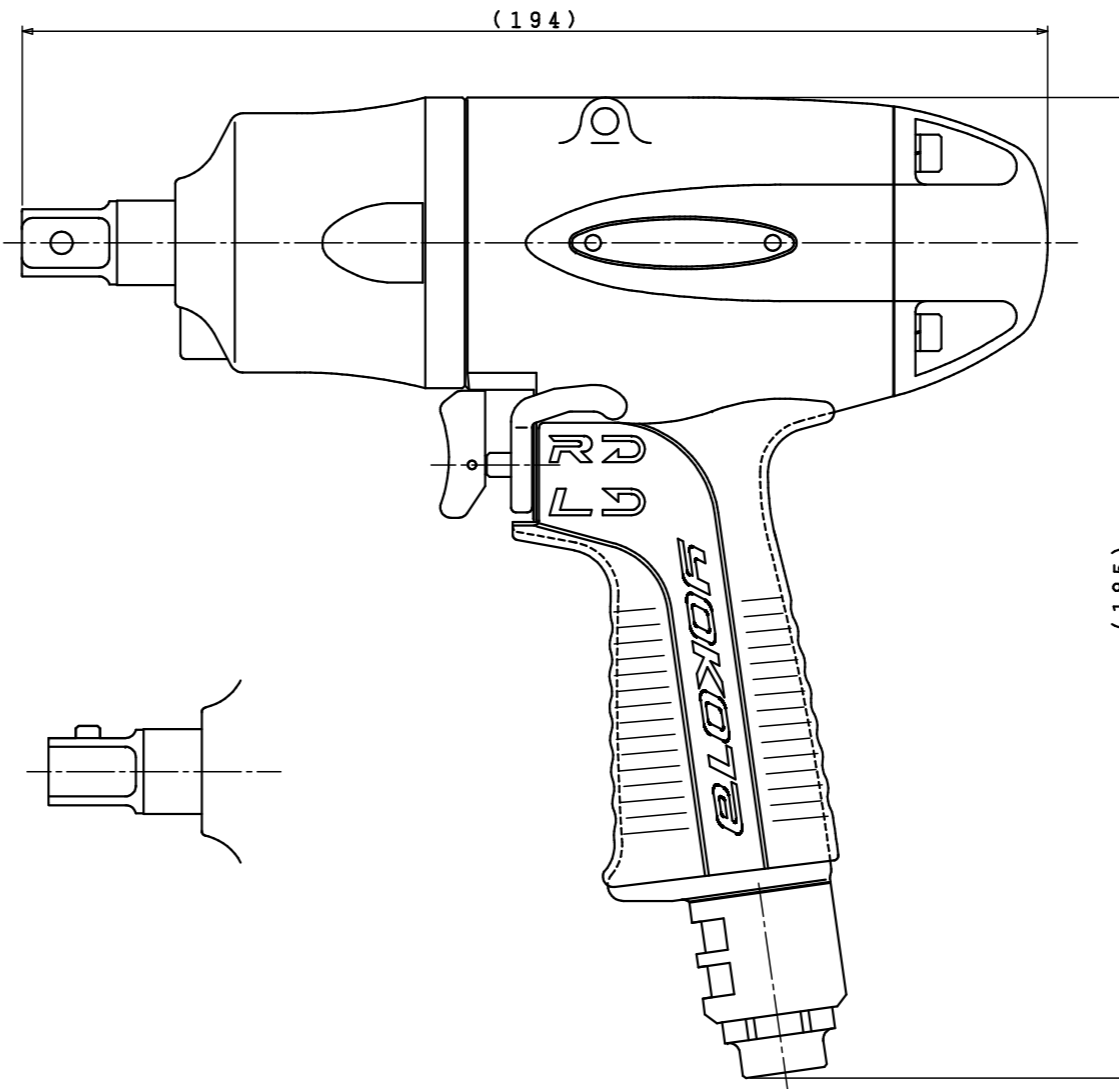

YLT110E  
YLT110EL

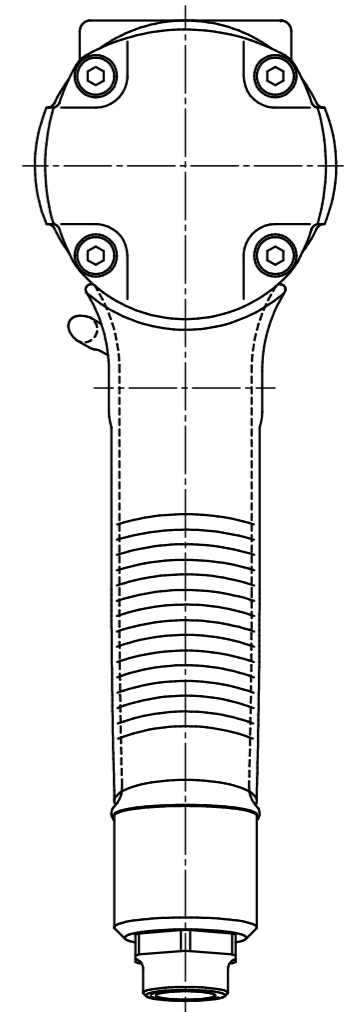
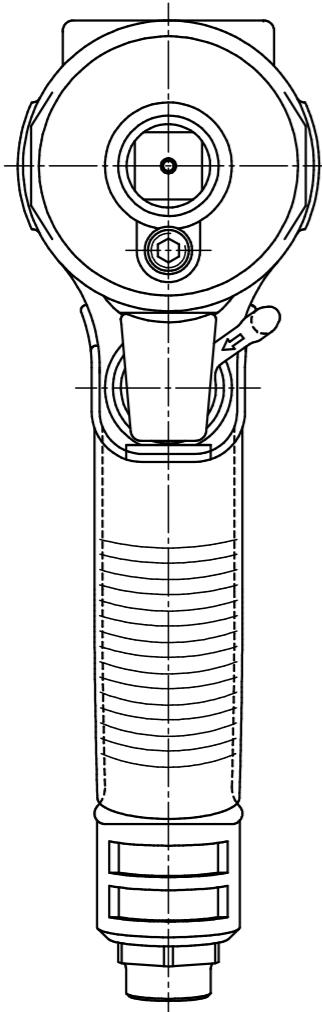

型式	YLT110シリーズ
名称	外觀図
尺度	1:1
製品番号	別記
 ヨコタ工業株式会社	